

Features

- Diffused Junction
- Low Forward Voltage Drop
- High Current Capability
- High Reliability
- High Surge Current Capability

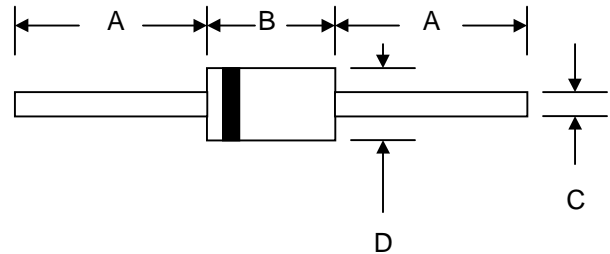

Mechanical Data

- Case: DO-201AD, Molded Plastic
- Terminals: Plated Leads Solderable per MIL-STD-202, Method 208
- Polarity: Cathode Band
- Weight: 1.2 grams (approx.)
- Mounting Position: Any
- Marking: Type Number
- **Lead Free: For RoHS / Lead Free Version, Add "-LF" Suffix to Part Number, See Page 4**

DO-201AD		
Dim	Min	Max
A	25.4	—
B	7.20	9.50
C	1.20	1.30
D	4.80	5.30
All Dimensions in mm		

Maximum Ratings and Electrical Characteristics @ $T_A=25^\circ\text{C}$ unless otherwise specified

Single Phase, half wave, 60Hz, resistive or inductive load.
For capacitive load, derate current by 20%.

Characteristic	Symbol	HER 501	HER 502	HER 503	HER 504	HER 505	HER 506	HER 507	HER 508	Unit	
Peak Repetitive Reverse Voltage	V_{RRM}	50	100	200	300	400	600	800	1000	V	
Working Peak Reverse Voltage	V_{RWM}										
DC Blocking Voltage	V_R										
RMS Reverse Voltage	$V_{R(RMS)}$	35	70	140	210	280	420	560	700	V	
Average Rectified Output Current (Note 1)	I_O	5.0								A	
		@ $T_A = 55^\circ\text{C}$									
Non-Repetitive Peak Forward Surge Current 8.3ms Single half sine-wave superimposed on rated load (JEDEC Method)	I_{FSM}	150								A	
Forward Voltage	V_{FM}	1.0			1.3		1.7			V	
		@ $I_F = 5.0\text{A}$									
Peak Reverse Current	I_{RM}	10								μA	
At Rated DC Blocking Voltage		100									
		@ $T_A = 25^\circ\text{C}$ @ $T_A = 100^\circ\text{C}$									
Reverse Recovery Time (Note 2)	t_{rr}	50					75				nS
Typical Junction Capacitance (Note 3)	C_j	75					50				pF
Operating Temperature Range	T_j	-65 to +125								$^\circ\text{C}$	
Storage Temperature Range	T_{STG}	-65 to +150								$^\circ\text{C}$	

Note: 1. Leads maintained at ambient temperature at a distance of 9.5mm from the case
2. Measured with $I_F = 0.5\text{A}$, $I_R = 1.0\text{A}$, $IRR = 0.25\text{A}$. See figure 5.
3. Measured at 1.0 MHz and applied reverse voltage of 4.0V D.C.

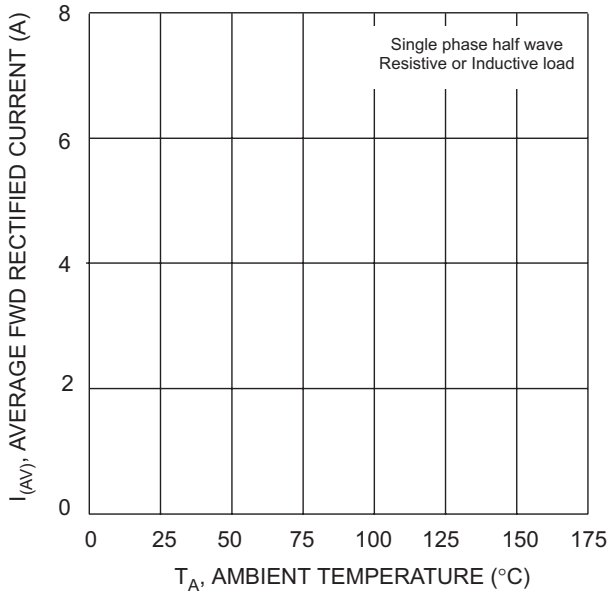

Fig. 1 Forward Current Derating Curve

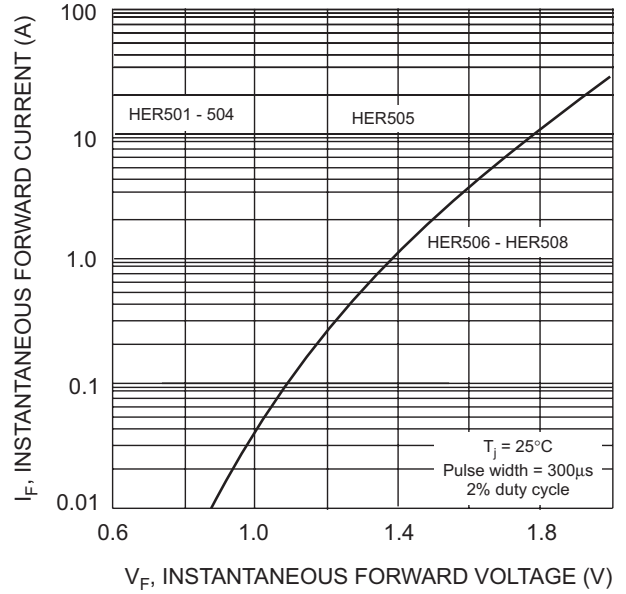

Fig. 2 Typical Forward Characteristics

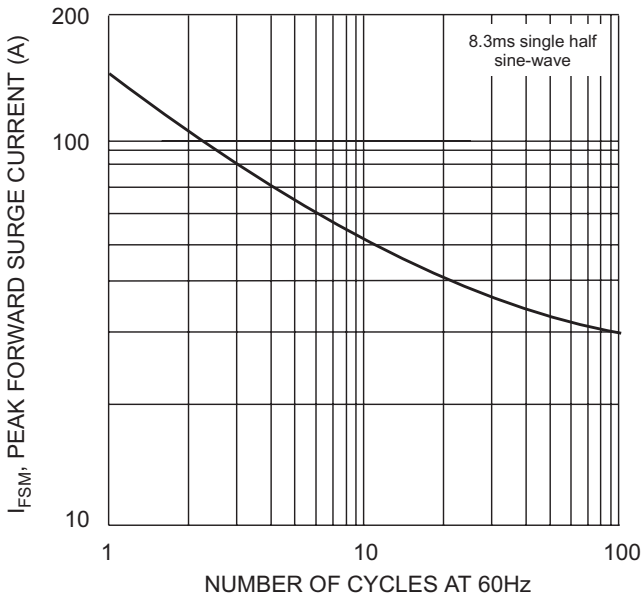

Fig. 3 Peak Forward Surge Current

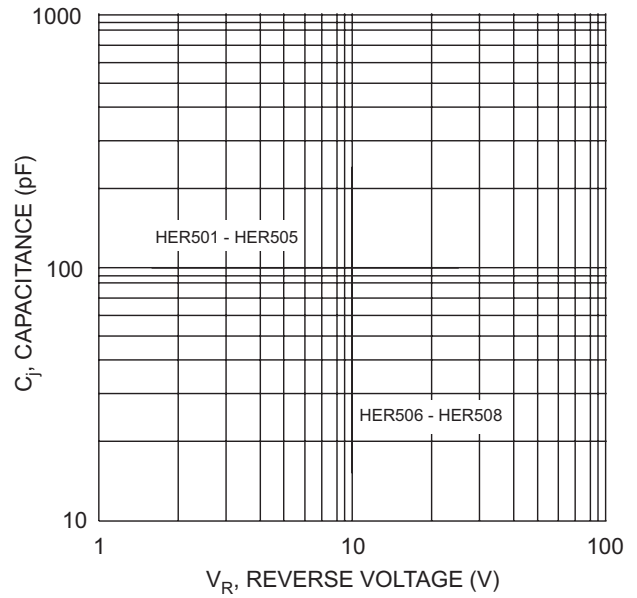
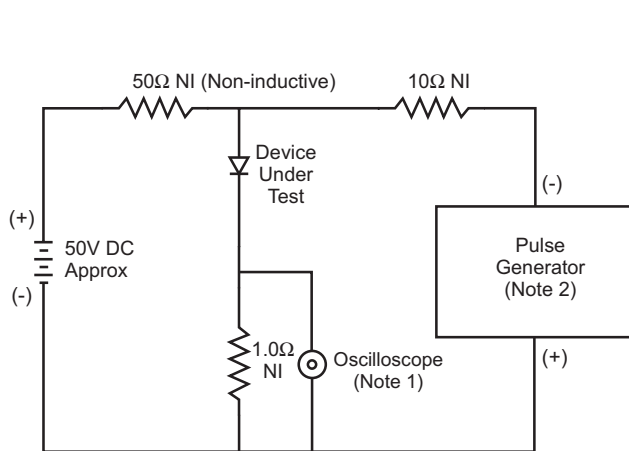

Fig. 4 Typical Junction Capacitance



Notes:

1. Rise Time = 7.0ns max. Input Impedance = 1.0MΩ, 22pF.
2. Rise Time = 10ns max. Input Impedance = 50Ω.

Set time base for 5/10ns/cm

Fig. 5 Reverse Recovery Time Characteristic and Test Circuit

MARKING INFORMATION

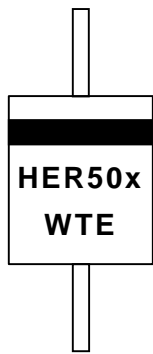

Cathode = Polarity Band
 HER50x = Device Number
 x = 1, 2, 3, 4, 5, 6, 7 or 8
 WTE = Manufacturer's Logo

TAPING SPECIFICATIONS



PACKAGING INFORMATION

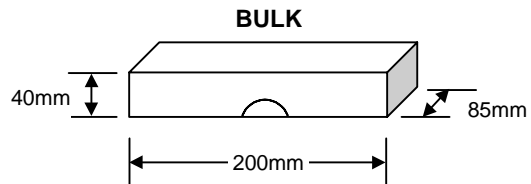

Packaging	Reel Diameter / Box Size (mm)	Quantity (PCS)	Carton Size (mm)	Quantity (PCS)	Approx. Gross Weight (KG)
TAPE & REEL	330	1,200	370 x 370 x 420	6,000	10.0
TAPE & BOX	255 x 75 x 150	1,200	400 x 273 x 415	12,000	17.0
BULK	200 x 85 x 40	500	459 x 214 x 256	12,500	16.0

Note: 1. Paper reel, white or gray color. Core material: plastic or metal.
 2. Components are packed in accordance with EIA standard RS-296-E.

ORDERING INFORMATION

Product No.	Package Type	Shipping Quantity
HER501-T3	DO-201AD	1200/Tape & Reel
HER501-TB	DO-201AD	1200/Tape & Box
HER501	DO-201AD	500 Units/Box
HER502-T3	DO-201AD	1200/Tape & Reel
HER502-TB	DO-201AD	1200/Tape & Box
HER502	DO-201AD	500 Units/Box
HER503-T3	DO-201AD	1200/Tape & Reel
HER503-TB	DO-201AD	1200/Tape & Box
HER503	DO-201AD	500 Units/Box
HER504-T3	DO-201AD	1200/Tape & Reel
HER504-TB	DO-201AD	1200/Tape & Box
HER504	DO-201AD	500 Units/Box
HER505-T3	DO-201AD	1200/Tape & Reel
HER505-TB	DO-201AD	1200/Tape & Box
HER505	DO-201AD	500 Units/Box
HER506-T3	DO-201AD	1200/Tape & Reel
HER506-TB	DO-201AD	1200/Tape & Box
HER506	DO-201AD	500 Units/Box
HER507-T3	DO-201AD	1200/Tape & Reel
HER507-TB	DO-201AD	1200/Tape & Box
HER507	DO-201AD	500 Units/Box
HER508-T3	DO-201AD	1200/Tape & Reel
HER508-TB	DO-201AD	1200/Tape & Box
HER508	DO-201AD	500 Units/Box

1. Products listed in **bold** are WTE **Preferred** devices.
2. Shipping quantity given is for minimum packing quantity only. For minimum order quantity, please consult the Sales Department.
3. **To order RoHS / Lead Free version (with Lead Free finish), add "-LF" suffix to part number above. For example, HER501-TB-LF.**

Won-Top Electronics Co., Ltd (WTE) has checked all information carefully and believes it to be correct and accurate. However, WTE cannot assume any responsibility for inaccuracies. Furthermore, this information does not give the purchaser of semiconductor devices any license under patent rights to manufacturer. WTE reserves the right to change any or all information herein without further notice.

WARNING: DO NOT USE IN LIFE SUPPORT EQUIPMENT. WTE power semiconductor products are not authorized for use as critical components in life support devices or systems without the express written approval.

Won-Top Electronics Co., Ltd.

No. 44 Yu Kang North 3rd Road, Chine Chen Dist., Kaohsiung, Taiwan

Phone: 886-7-822-5408 or 886-7-822-5410

Fax: 886-7-822-5417

Email: sales@wontop.com

Internet: http://www.wontop.com

We power your everyday.